

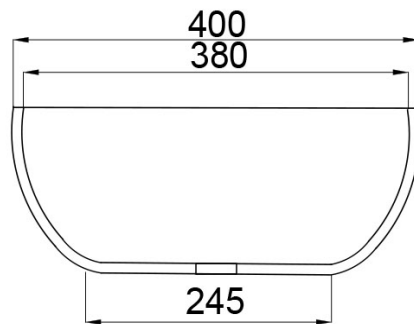

JEE-O moloko basin specifications

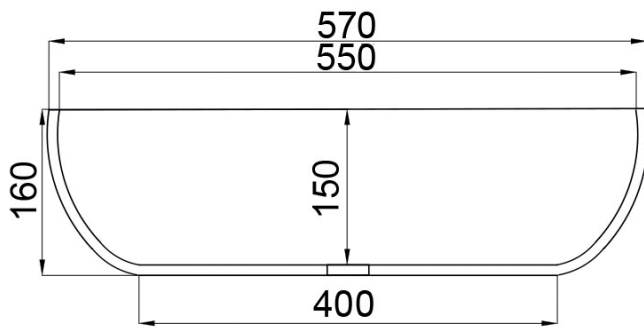
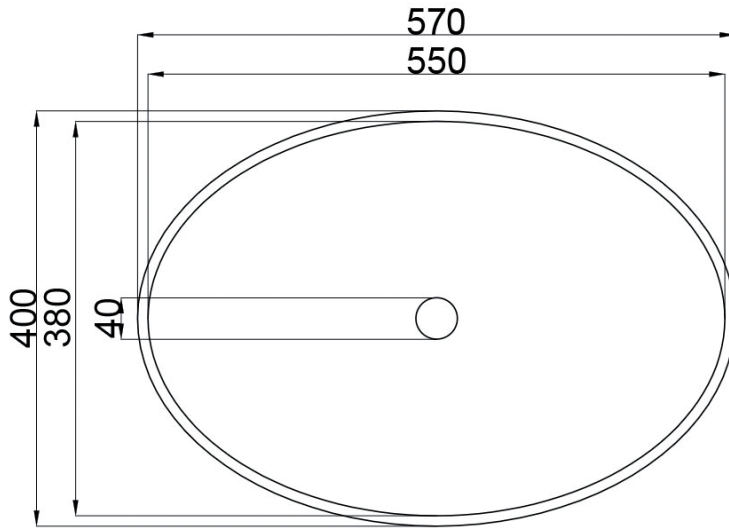

Article code:

SWMBAS20
White DADOquartz

Material:

DADOquartz - Scratch & abrasion resistant

Waste diameter:

40mm

Dimensions:

L 57 x W 40 x H 16 cm

Basin rim:

1 cm

Net weight:

15kg

Note: cast products are subject to size variation of +/-5 %

Dimension package:

L 60 x W 45 x H 19 cm

Package weight:

5kg

UV stability:

6 / BSEN438

25 year warranty

HS code:

69109000

European Standard:

NEN-EN 14688-2015

