

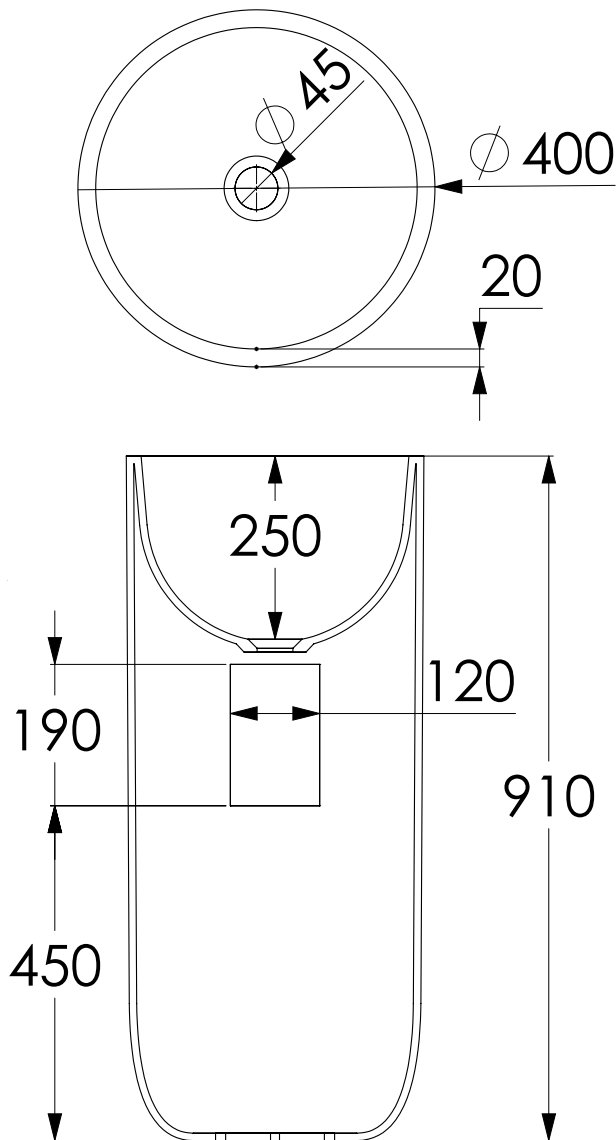

JEE-O flow high specifications



Article code:

SWMBAS72

● White DADOquartz

SWMBAS72 - black RAL 9005

● Spray painted matt outside

SWMBAS72 - green RAL 6003

● Spray painted matt outside

SWMBAS72 - grey RAL 7040

● Spray painted matt outside

Material:

DADOquartz - Scratch & abrasion resistant

Coating:

Spray painted matt outside

Waste diameter:

40 mm

Dimensions:

L 40 x W 40 x H 91 mm

Basin rim:

2 cm

Net weight:

25kg

Note: cast products are subject to size variation of +/- 5 %

Dimension package:

L 50 x W 50 x H 100 mm

Package weight:

5kg

UV stability:

6 / BSEN438

25 year warranty

HS code:

69109000

European Standard:

NEN-EN 14688-2015

