

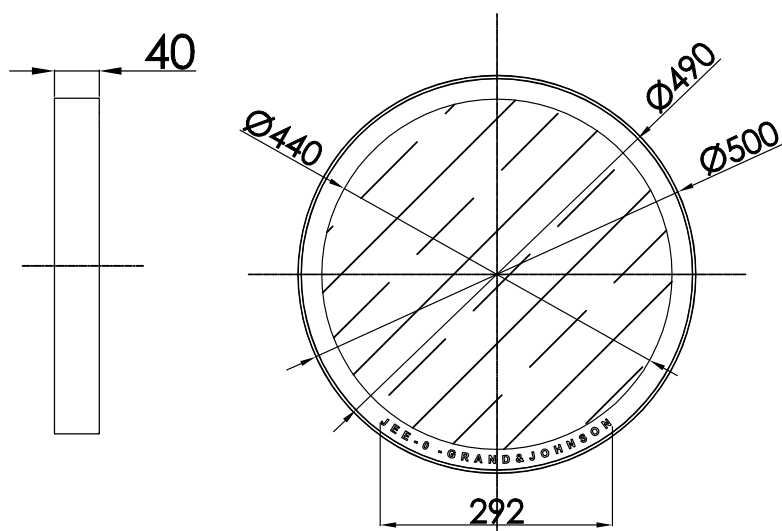

JEE-O soho mirror 50 specifications



Note:
UV radiation and extreme temperature
can affect the color and structure of the
JEE-O soho wall surface.

Article code:

701-0120

● Brushed stainless steel - **RAW**

701-0122

● Hammercoated black matt

701-0128 green RAL 6003

● Powder coating matt

701-0129 grey RAL 7040

● Powder coating matt

Dimension package:

L 54 x W 54 x H 8 cm

Total weight:

4.34 kg

Package weight:

0.96 kg

2 year warranty

Material:

Stainless Steel r304

Coating:

1.5 Electro powder spray

Cleaning:

soapwater or alcohol

HS code:

70099200